

VS20 OEM Spectrograph Family

HORIBA Scientific OEM division
release a new line of sub-miniature spectrographs
for OEM customers*
dedicated to industrial applications

* recurring and volume business (not retail)

Typical Applications

- UV-VIS spectrophotometry
- Analytical chemistry
- Color management
- Life science
- Bio - medical
- Semicon metrology
- Process monitoring
- Solar cell production
- Mineralogy
- and many others ...

Features & Benefits

- Miniature for hand held instruments
- Low stray light
- Superb imaging properties
- Reliable
- Excellent thermal stability

Based on the success of the CP20 miniature spectrograph, the new VS20 family is now available in 4 versions, covering the entire spectral range from 200 to 1700 nm



VS20 UV-VIS

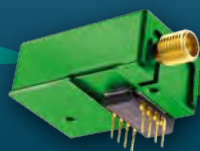

VS20 VIS

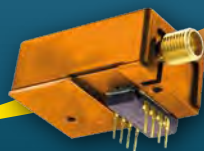

VS20 VIS-NIR

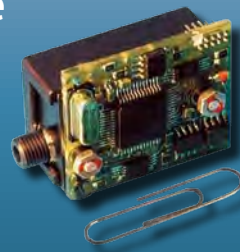

VS20 NIR

The VS20 fits perfectly into small, hand-held, portable instruments, and can replace larger spectrographs when space is at a premium



Components

Entrance

The **VS20** is equipped with an integrated fixed slit and can be operated either with free beam optics or using optical fibers (e. g. SMA).



Standard slit size is 50 or 100 μm
(Custom sizes available on request).

Grating

The **VS20** is based on our famous concave holographic gratings (**aberration corrected, type IV**) with a 20 mm focal length and f/2.7 aperture.



They • *maximize the optical performance*

- *minimize the stray-light*
- *feature a high efficiency*
- *have the largest aperture in their class*
- *offer a large choice of spectral ranges*
- *are available with many different linear array detectors*

The gratings are manufactured using **HORIBA Scientific's** proprietary "High Volume Manufacturing Process".

Order Sorting Filter

Higher grating orders are suppressed to unsurpassed low levels by our optimized order sorting filters.

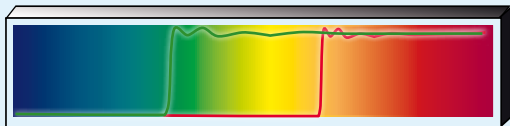

These filters are tailored to our grating/detector combinations to enable the full spectral range without compromise in performance.

Mechanical Design

The base structure of the **VS20** has been optimized in view of ensuring the main demands of hand-held and portable spectrometers: **robustness, thermal and mechanical stability**, and **reliability**, even at unusual environmental conditions.

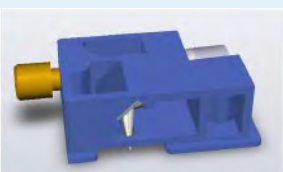

Detectors

The **VS20's** special spectrograph design gives ultimate freedom in detector selection: different linear or 2D arrays, even custom arrays for specific applications are possible.

Well tested standard solutions are:

Photodiode Arrays (PDA), CMOS or NMOS

- S837X, S390X, or S1011X (new array)
128 or 256 pixels with 25 or 50 μm width and 0.5 or 2.5 mm height



Large CMOS sensor arrays

- ELIS1024 or S9227 (1024 pixels)

InGaAs sensor arrays (TE cooled)

- G9211-256, SU256-LSB
128 or 256 pixels with 25 or 50 μm width and 500 μm height



Electronic Driver

As an option, high performance and compact electronic boards are available and feature:

- ◆ 16 bit ADC
- ◆ Trigger in/out
- ◆ Interface: USB 2.0
- ◆ Power supply + 5.2 V (180 mA)

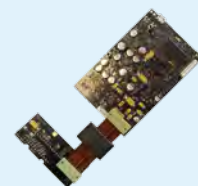

Evaluation unit electronics includes acquisition software, based on **LabVIEW 8.5** featuring:

- Absorbance and transmission calculations
- On-board wavelength calibration
- Linearity correction On/Off
- On-board or software averaging
- Data saving to Excel or ASCII
- LabView VIs and top level code (C++, VBA...) for customizations



This software is only available with evaluation units !!!

VS20 UV-VIS

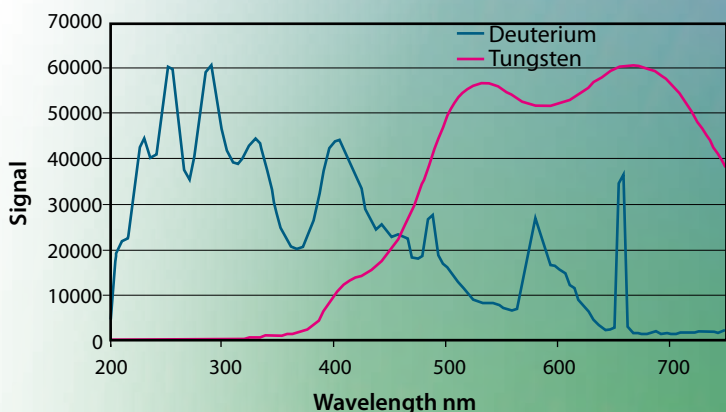
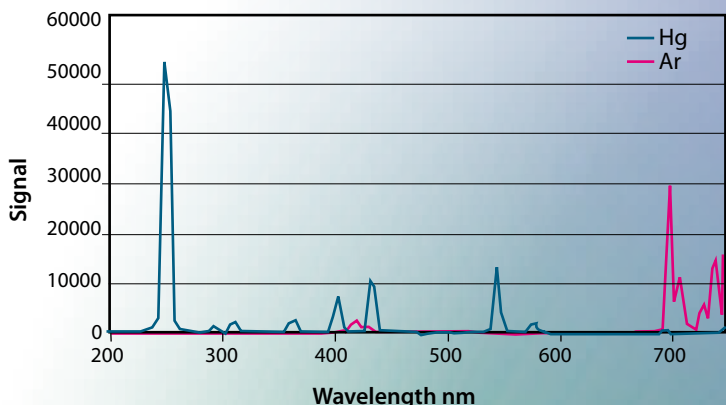

spectral range	200-750 nm
optical geometry	concave flat field grating
focal length	20 mm
aperture	f# 2.7
resolution	< 11 nm with 100 μ m slit < 6.5 nm with 50 μ m slit
average dispersion	90 nm/mm
spectrum length	6.35 mm
wavelength accuracy	\leq 0.5 nm (with a 3 rd order polynom. fit)
reproducibility	\leq 0.1 nm
straylight	< 0.25 % @ 260 nm with deuterium lamp and with GG 495 + OD filter *
temperature induced drift	< 0,03 nm/ $^{\circ}$ C (between 20 to 45 $^{\circ}$ C)
Dimensions	15 x 22 x 35 mm ³

*Stray light specification is very dependent of testing conditions, light source, aperture and fiber!

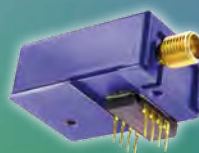

Applications:

- UV-VIS spectrophotometry
- Water quality
- Process monitoring
- Semicon metrology
- ...

VS20 VIS

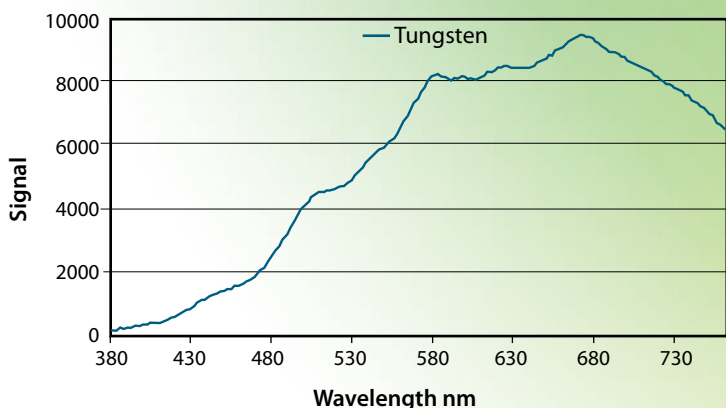
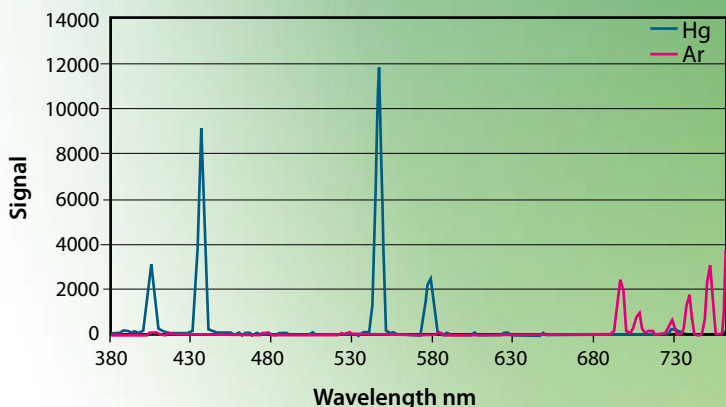

spectral range	380-760 nm
optical geometry	concave flat field grating
focal length	20 mm
aperture	f# 2.7
resolution	< 10 nm with 100 μ m slit < 6 nm with 50 μ m slit
average dispersion	65 nm/mm
spectrum length	6.35 mm
wavelength accuracy	\leq 0.5 nm (with a 3 rd order polynom. fit)
reproducibility	\leq 0.1 nm
straylight	< 0.1 % @ 400 nm with tungsten lamp, and with GG 495 + OD filter *
temperature induced drift	< 0.03 nm/ $^{\circ}$ C (between 20 to 45 $^{\circ}$ C)
dimensions	15 x 22 x 35 mm ³

*Stray light specification is very dependent of testing conditions, light source, aperture and fiber!

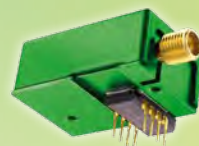

Applications:

- Color measurement
- Analytical chemistry
- LED testing
- Solar cell production
- ...

VS20 VIS-NIR

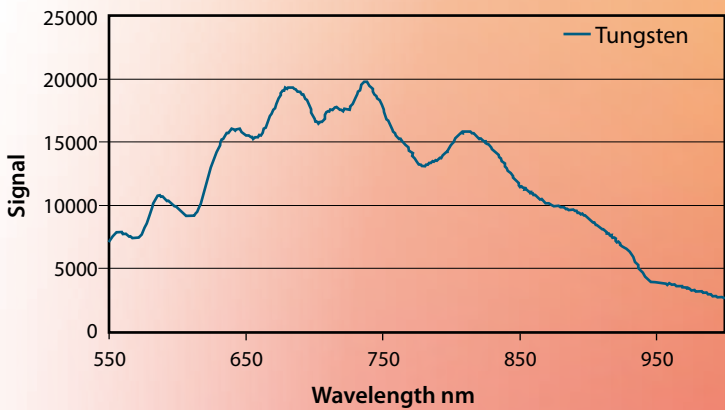
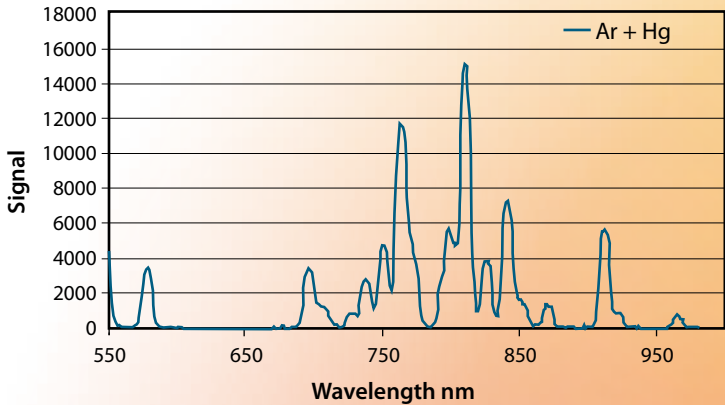

spectral range	550-1015 nm
optical geometry	concave flat field grating
focal length	20 mm
aperture	f# 2.7
resolution	< 10 nm with 100 μ m slit < 6 nm with 50 μ m slit
average dispersion	75 nm/mm
spectrum length	6.35 mm
wavelength accuracy	\leq 0.5 nm (with a 3 rd order polynom. fit)
reproducibility	\leq 0.1 nm
straylight	< 0.2 % @ 600 nm with tungsten lamp, and with RG 665 + OD filter *
temperature- induced drift	< 0.03 nm/ $^{\circ}$ C (between 20 to 45 $^{\circ}$ C)
dimensions	15 x 22 x 35 mm ³

*Stray light specification is very dependent of testing conditions, light source, aperture and fiber!

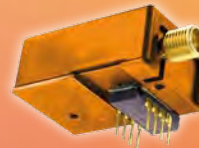

Applications:

- Reflexion spectroscopy
- Thin film measurement
- Bio - medical
- Solar radiation monitoring
- ...

VS20 NIR

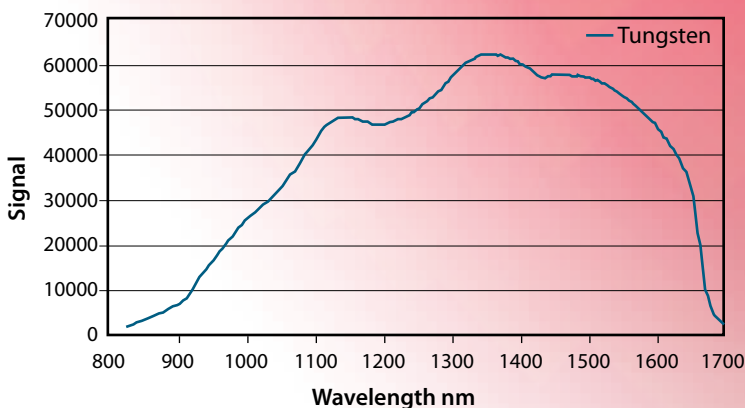
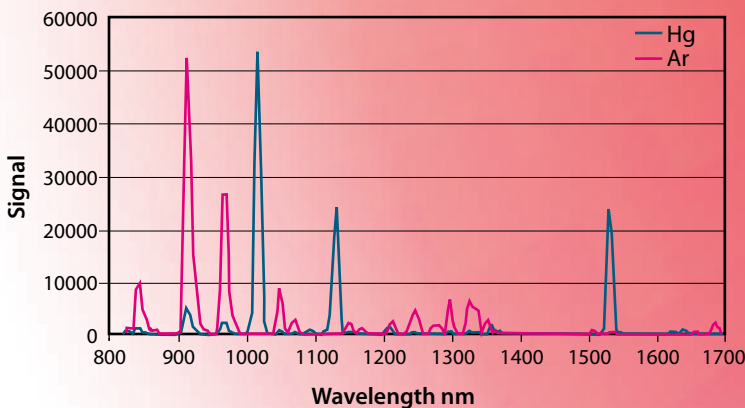

spectral range	800-1700 nm
optical geometry	concave flat field grating
focal length	20 mm
aperture	f# 2.7
resolution	< 11 nm with 100 μ m slit < 6.5 nm with 50 μ m slit
average dispersion	75 nm/mm
spectrum length	12.7 mm
wavelength accuracy	\leq 0.5 nm (with a 3 rd order polynom. fit)
reproducibility	\leq 0.1 nm
straylight	< 0.1 % @ 950 nm with tungsten lamp, and with RG 1000 + OD filter *
temperature- induced drift	< 0.03 nm/ $^{\circ}$ C (between 20 to 45 $^{\circ}$ C)
dimensions	16 x 36 x 65 mm ³

*Stray light specification is very dependent of testing conditions, light source, aperture and fiber!



Applications:

- Agri - food
- Semicon failor analysis
- Sorting of plastics
- Mineralogy
- ...

VS20 Imaging

With the new gratings of the **VS20** family, exceptional imaging performance is achieved giving unsurpassed spatial resolution along the slit.

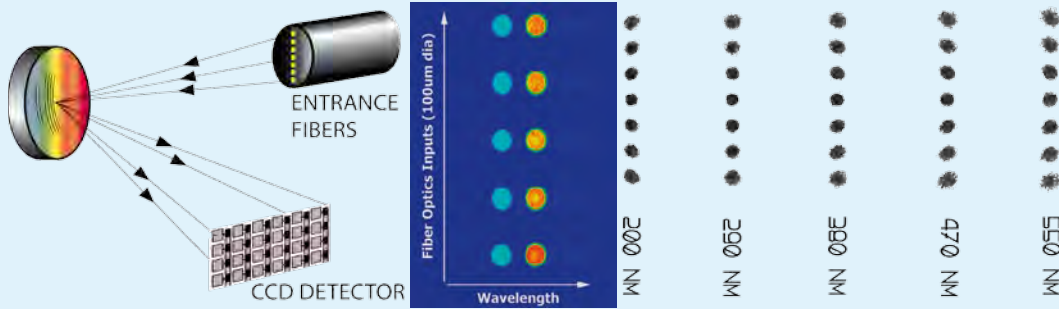

Despite the size, the **VS20** is a true **Imaging Spectrograph**, offering new capabilities like Spatial Multiplexing, or Hyperspectral Imaging to OEM customers.

It makes perfect use of multiple fiber inputs, or linear fiber arrays using a 2D array detector.

Evaluation Module SPECTRO CUBE

To reduce customer's development time and costs, we offer the „**SPECTRO³**“ evaluation module, exclusively to OEMs (not retail).

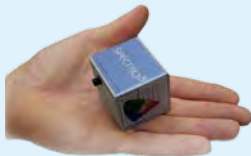

The goal is to speed up the instrument definition phase and identify the important performance parameters and specifications, which in turn will be used in the customization phase, leading to a unique solution for OEM quantities.

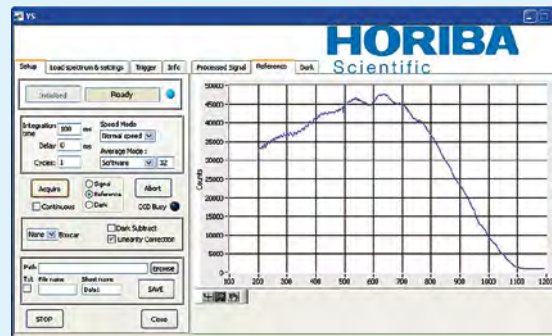

Mechanical Dimensions

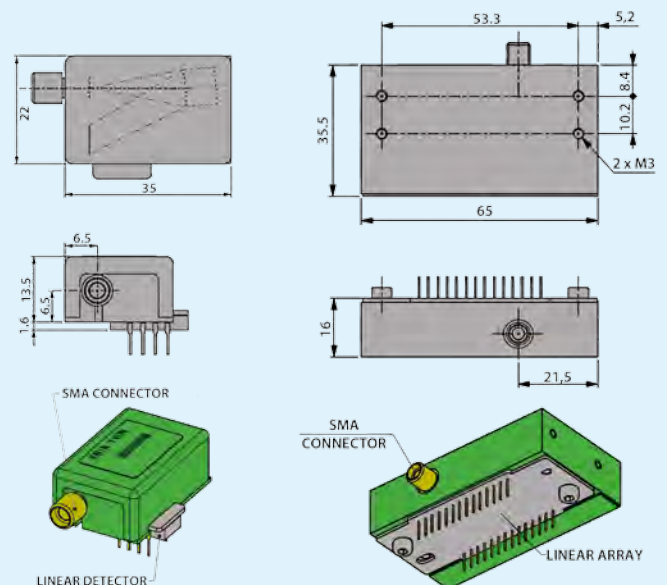

VS20 UV-VIS / VS20 VIS-NIR

VS20 NIR

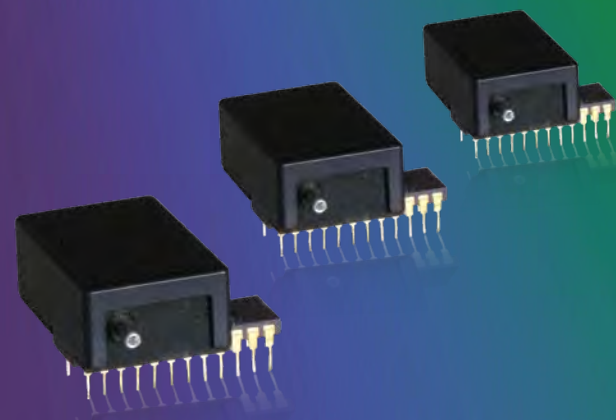

HORIBA Scientific attempts to provide accurate information in this leaflet, however **HORIBA Scientific** assumes no responsibility should errors or inaccuracies occur.

HORIBA Scientific reserves the right to change the content without notice and provides this leaflet "as is" with no warranty either express or implied.

How We Can Add Value to Your Products:

Established High Volume OEM Production

For over 40 years, the **OEM division** of **HORIBA Jobin Yvon** has



taken a leading position in the design, development and manufacture of diffraction gratings, spectrometers and optical systems.

We offer a complete range of capabilities from design to production to industrial customers.

With 2 global manufacturing sites and a network of trained optical partners, **HORIBA Scientific** offers a wide range of manufacturing capabilities from simple flat gratings to complex optical subassemblies.



A vertically integrated manufacturing operation enables us to control the entire manufacturing process and assures a superior quality product at competitive costs.

Thanks to an experienced team of manufacturing experts, we can deliver up to 50,000 pcs/year, and provide challenging ramp-up schedules.

HORIBA Scientific's goal is to provide high performance, robust, reliable gratings and spectrometers that are easily integrated into any system. We strive to deliver unmatched flexibility, reliability and quality.

Modularity and Customer Optimization

Our approach to spectroscopy is to offer different spectrometer families, offer the components in a modular system, and finally customize it to your needs, to balance performance and costs.

Ultimately, we are able to develop new spectrometers (monochromators and spectrographs) based on your specifications.

Partnership

The **OEM support team** can assist you in selecting the best solution for your particular application. With us, you can utilize your industry expertise and resources to focus on developing unique technologies instead of reinventing existing ones. We reduce engineering and manufacturing time and costs, and help you to get your products to market faster.



**You can take advantage of our spectroscopic experience
and become our next industrial partner
for your next spectroscopy project.**



HORIBA
Scientific

France:
HORIBA Jobin Yvon SAS
16-18 rue du Canal
91165 Longjumeau Cedex
Tel.: +33 (0)1 64 54 13 00

E-Mail: oemsales.jyfr@horiba.com

Germany:
HORIBA Jobin Yvon GmbH
Hauptstr. 1
82008 Unterhaching
Tel.: +49 (0)89 46 23 17-0

E-Mail: info-sci.de@horiba.com

USA:
HORIBA Jobin Yvon Inc.
3880 Park Avenue
Edison, NJ 08820-3097
Tel.: 1 732 494 8660 Ext.: 224

E-Mail: oem@jobinyvon.net

www.horiba.com/scientific

UK: +44 (0)20 8204 8142 • **Italy:** +39 0 2 5760 3050 • **Japan:** +81 (0)3 38618231 • **China:** +86 (0)10 8567 9966 • **Other Countries:** +33 (0)1 64 54 13 00

Explore the future

Automotive Test Systems | Process & Environmental | Medical | Semiconductor | Scientific

HORIBA